

SF₆ Gas Insulated Ring Main Unit *Susol* RMU



Susol
Super Solution

Ring Main Unit

LSI

Ring Main Unit

The best solution for Power Distribution Systems



Contents

- | | | |
|-------------------------|---|-----------------------------|
| 4 Features | 10 Intelligent application | 14 Load Break Switch |
| 6 Configurations | 12 Main characteristics
Detailed characteristics
for each function | 15 Circuit Breaker |



Susol RMU

A Compact Switchgear Solution for Secondary Distribution (Ring Main Unit Up to 24kV, SF₆-Insulated)

Susol RMU is enable to install on medium voltage distribution network and mainly used for protection of transformers in compact substations. It is used for medium voltage distribution in compact substations, small buldings, residential housing complex, large shopping malls, airports, wind power, etc. comprising medium voltage networks.

The concept of Susol RMU is offering a choice of other switch-fuse combination or Circuit Breaker with relay for protection of the transformer.



16 Fuse combination Switch

22 Operational sequence

25 Ordering Information

17 Optional compartments

23 Dimensions

26 Quality assurance



Susol RMU is the solution to meet your medium voltage power distribution line needs.

Susol RMU is a compact ring main unit combining all MV functional units to enable to supply and protect transformers on the secondary distribution network.

Susol RMU can be supplied in various and different configurations suitable for most switching applications in 12 / 17.5 / 24kV distribution networks

Technology

- Metal enclosed unit for indoor installation and type tested.
- Insulated by SF₆ Gas.
- Maintenance free and easy installation.
- Independent of climate.
- ON-OFF-Earth, 3-position load break switch

Safety

- Approachable and operable safety in the presence of power in the cables.
- Clear indication of operation status via mimic diagram on front panel.
- Fully automatic interlocking system.
 - Operation is only possible in case door is totally closed.
 - Fuse compartment is only accessible when Load break switch is earthed.
 - Voltage detector to check whether cables are lined or not.
- Internal arc withstand is tested for the operator safety in case of accident current occur.

Durability and usefulness

- Metal enclosed tank is hermetically sealed, it means this is independent of environmental effects such as dirt, small insects, moisture and so on.
- Load break switch operating is possible in the front of Ring Main Unit.
- All switching operations can be made safely to personnel because of interlocking system that operates automatically according to the switch position by the operator.
- No requirement of recharging SF₆ gas until its service life.
- Remote operation available in case of using motor operating mechanism and RTU.
- HRC power fuse will trip the mechanism automatically by a fuse striker pin connected to mechanism in the event of fault happening.

Saving cost

- No maintenance is required other than replacement of HRC Power Fuse after installation.
- Compact design that requires minimum space to install and operate locally is main advantage especially where the space is limited.

Non-Extensible CB Feeder (LCL) & Fuse Feeder (LFL) RMU

Extensible LBS Feeder (L), CB Feeder (C) & Fuse Feeder (F)



LCL type

LFL type

Extensible type

Non-Extensible CB Feeder RMU (LCL)

2 LBS & 1 CB-DS in single chamber.

- **L : LBS (Load Break Switch)**
3-position Load Break Switch rated 630A and less for load breaking and earthing
- **C : VCB (Vacuum Circuit Breaker)**
Circuit Breaker with 21kA interrupting capacity for the transformer and line protection
- **Horizontal cable bushing in front**

- 1 Ring S / W Earth operation
- 2 Circuit Breaker operation
- 3 Ring S / W operation
- 4 Pressure gauge
- 5 Earth S / W operation
- 6 Name plate
- 7 Voltage Indicator
- 8 Disconnecter S / W operation
- 9 Cable compartment

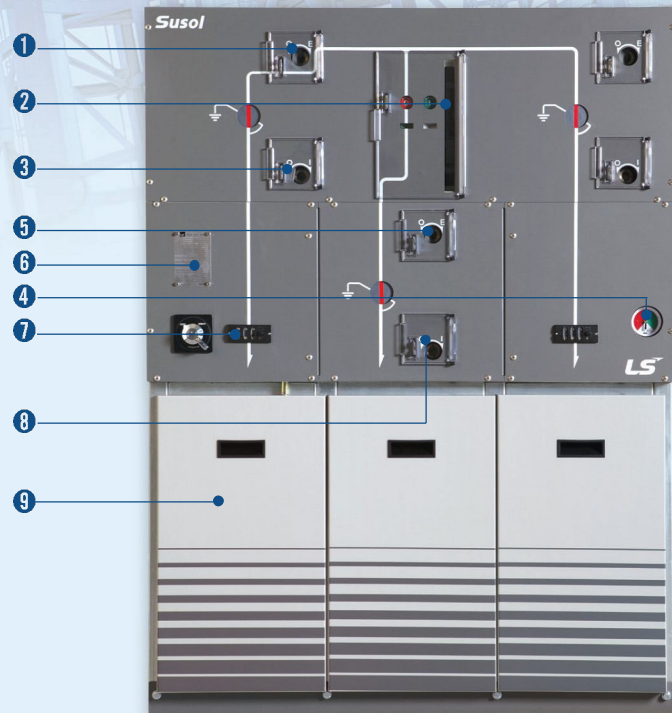

Configurations (Non-Extensible RMU)

• Information of model name

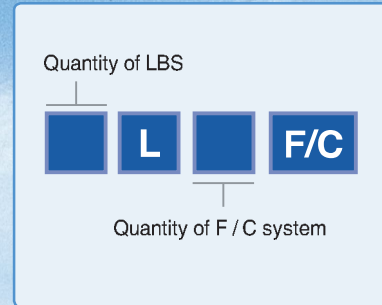
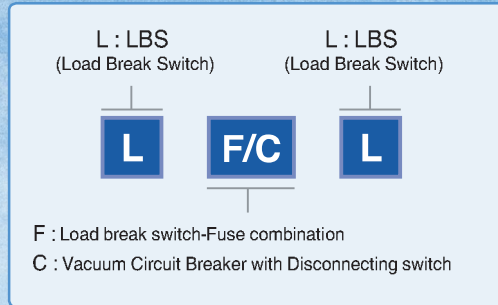

• Diagram, standard types

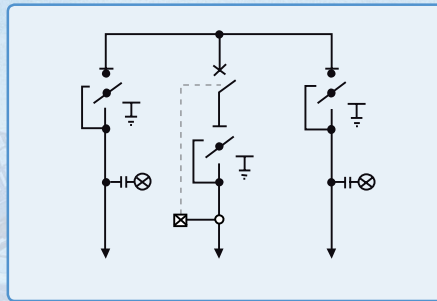

LCL (2L1C)

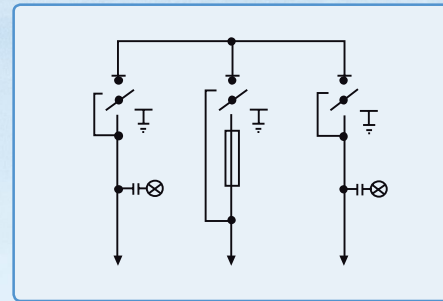

LFL (2L1F)

Non-Extensible Switch-Fuse Feeder RMU (LFL)

2 LBS & 1 Switch-Fuse in single chamber.

- **L : LBS (Load Break Switch)**
3-position Load Break Switch rated 630A and less for load breaking and earthing
- **F : Switch Fuse (Load Break Switch-Fuse combination)**
200A switch-fuse combination for transformer protection
- **Horizontal cable bushing in front**

- 1 Ring S / W Earth operation
- 2 T-off operation
- 3 Ring S / W operation
- 4 Pressure gauge
- 5 Voltage Indicator
- 6 Cable compartment
- 7 Fuse compartment
- 8 Name plate

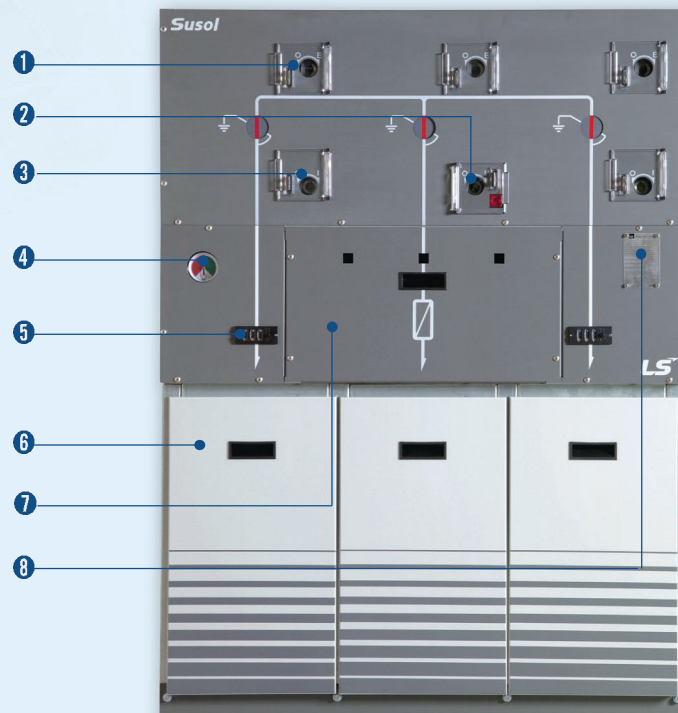

Configurations (Extensible RMU)

• Information of model name

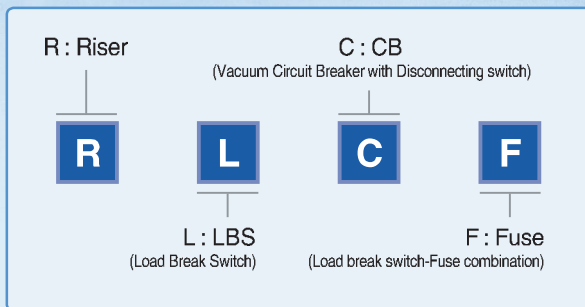

• Diagram, standard types

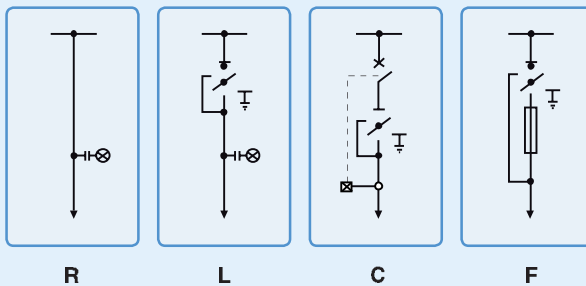

- 1 Pressure gauge
- 2 Name plate
- 3 Voltage detector
- 4 Cable compartment
- 5 Ring S / W Earth operation
- 6 Ring S / W operation
- 7 Circuit Breaker operation
- 8 Disconnecter S / W Earth operation
- 9 Disconnecter S / W operation
- 10 T-OFF operation
- 11 Fuse compartment

Extensible LBS Feeder RMU (L)

- L : LBS (Load Break Switch)
3-position Load Break Switch rated 630A and less for load breaking and earthing

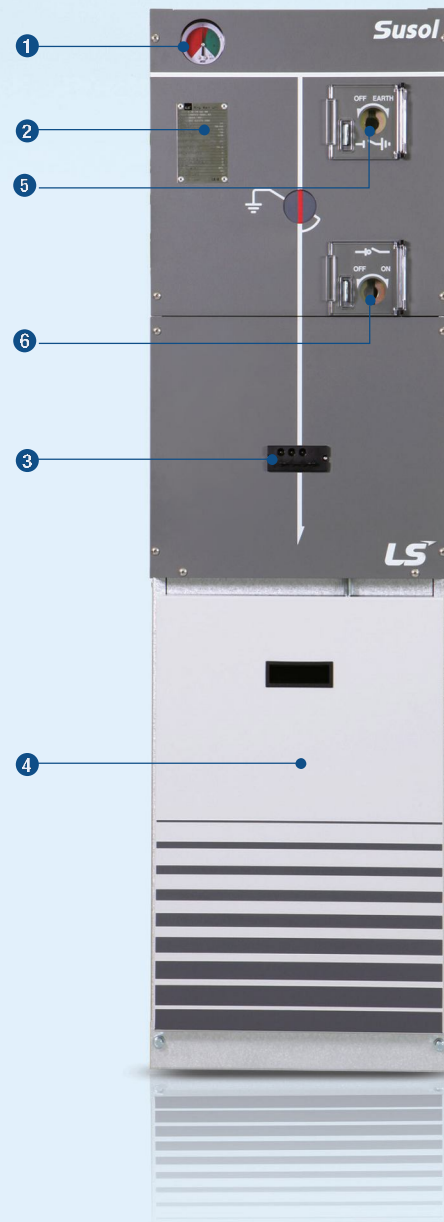

Extensible CB Feeder RMU (C)

- **C : VCB (Vacuum Circuit Breaker)**
Circuit Breaker with 21kA interrupting capacity for the transformer and line protection

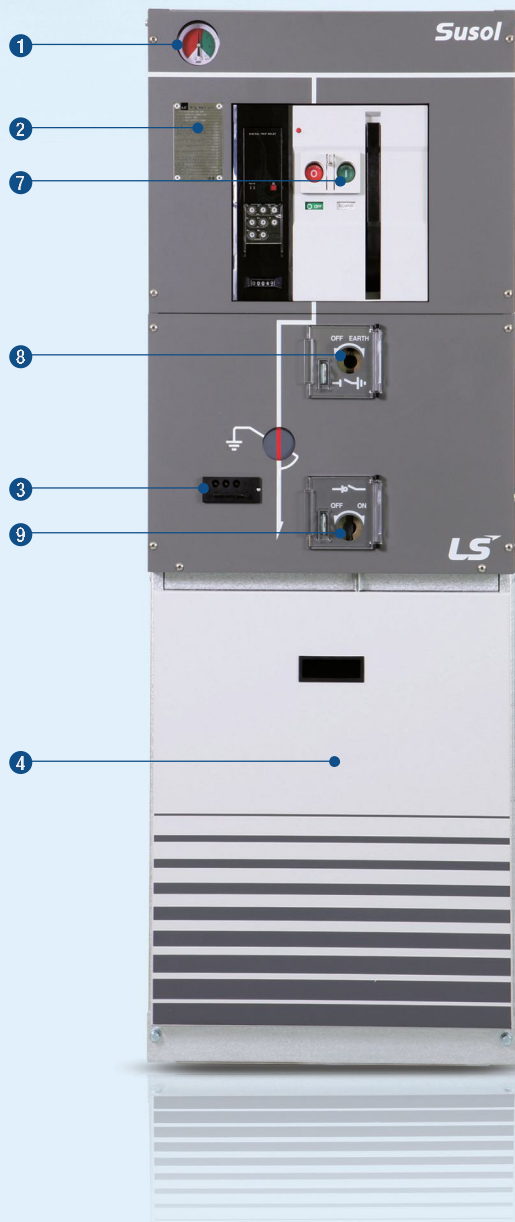

Extensible Switch-Fuse Feeder RMU (F)

- **F : Switch-Fuse Feeder**
(Load Break Switch-Fuse combination)
200A switch-fuse combination for transformer protection

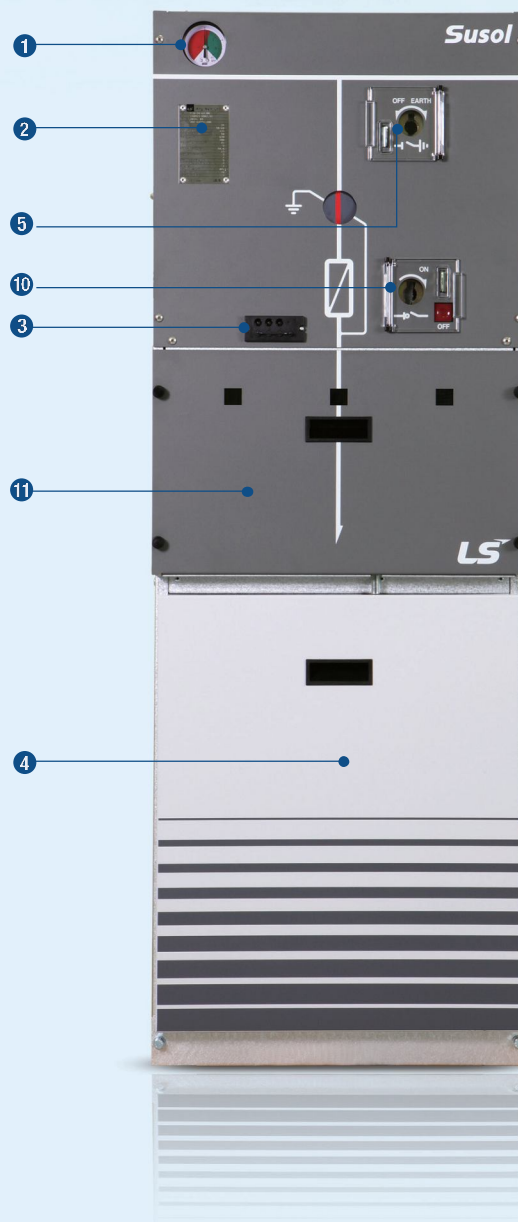



Intelligent application

Equipped with RTU (Remote Terminal Unit), the Susol RMU switchgear can implement intelligent application. Connecting all Susol RMU with communication network, it enables to monitor and control the switchgear remotely.

- RTU (Remote Terminal Unit)

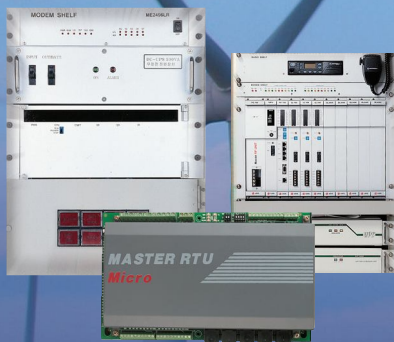

The Remote Terminal Unit (RTU) collects data from field instruments & sensors and transmits the information to the Supervisory Control and Data Acquisition System (SCADA) installed in a central control room through communication systems and lines, and receives control commands from the telemeter telecontrol system to conduct online controls in real time.

Network remote control for DAS / SCADA

Equipped with RTU (remote termination unit), the Susol RMU switchgear can implement intelligent application. Connecting all the IRMUs by a communication network, it enable to monitor and control the switchgear remotely, locate and isolate fault automatically as well as the system recovery. This will dramatically reduce the affected area and duration of blackout, and realize the high reliability and excellent power quality.

- **System configuration**

Susol RMU equipped with RTU provides all the functions needed to operate the MV network in real time

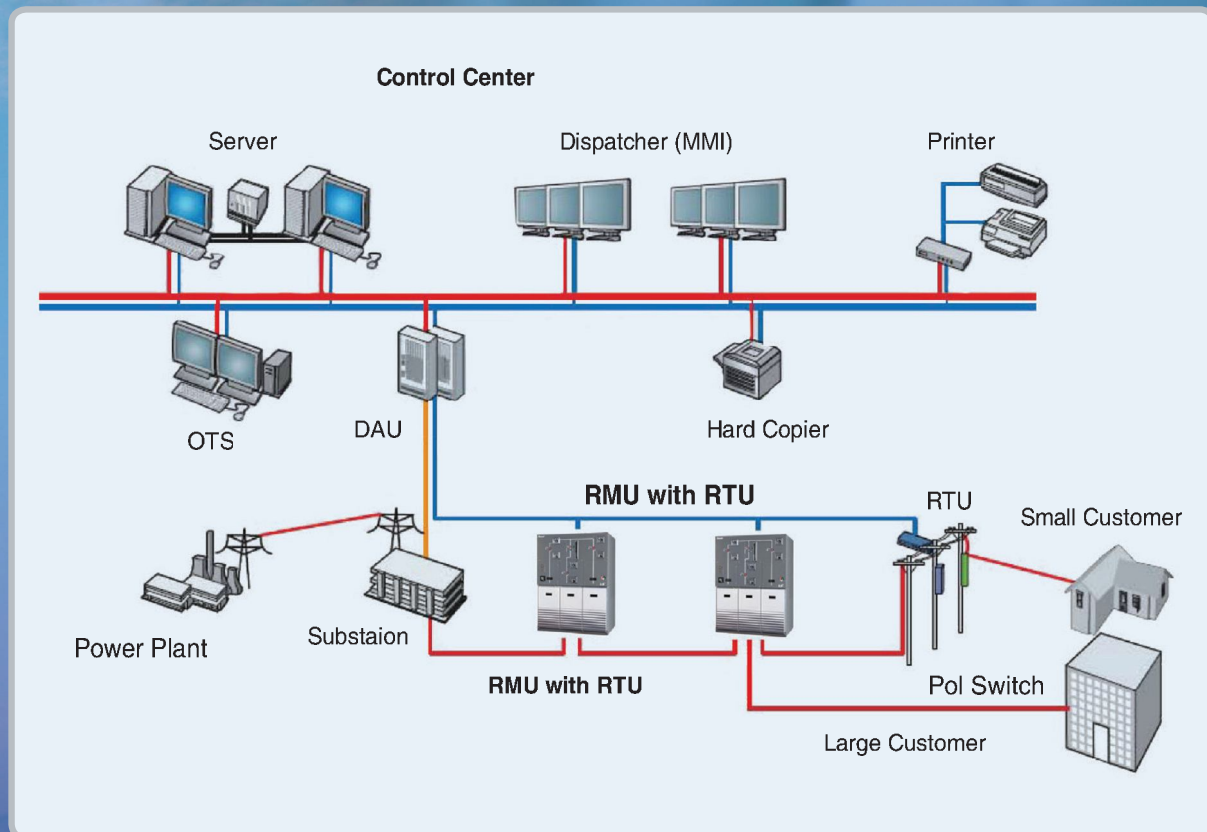

Main characteristics

Susol



LCL type



LFL type



Extensible type

Rating

Rated voltage	kV	12	17.5	24
Rated frequency	Hz	50/60	50/60	50/60
Rated power frequency withstand voltage	kV	28	38	50
Rated lightning impulse withstand voltage	kV	75	95	125
Rated current main busbars	A	630	630	630
Rated short-time withstand current (3s)	kA	21	21	21
Rated short-circuit making current	kA	54.6	54.6	54.6
Rated withstand arc current (1s, AFAL)	kA	21	21	21
Rated SF ₆ gas pressure	psi.G	5	5	5

Standards

Susol RMU meets international standards such as following

Standard	Description
IEC 62271-1	High-voltage switchgear and controlgear Part 1 : Common specifications
IEC 62271-100	High-voltage switchgear and controlgear Part 100 : Alternating-current circuit-breakers
IEC 62271-102	High-voltage switchgear and controlgear Part 102 : Alternating current disconnectors and earthing switches
IEC 62271-103	High-voltage switchgear and controlgear Part 103 : Switches for rated voltages above 1 kV up to and including 52 kV
IEC 62271-105	High-voltage switchgear and controlgear Part 105 : Alternating current switch-fuse combinations
IEC 62271-200	High-voltage switchgear and controlgear Part 200 : AC metal-enclosed switchgear and controlgear for rated voltages above 1 kV and up to and including 52 kV

Environment conditions

Conditions	Description
Temperatures	- Products should be stored and installed under the following conditions. - For stocking : from -40 °C to +60 °C - For working : from -25 °C to +40 °C - Other temperature, consult us.
Altitude	- Altitude for installation above sea level : under 1, 000 m
Humidity	- Relative humidity : max. 95 %

Additional information

Conditions	Description
Global options	- Manometer - VIS (Voltage Indication Systems) - All cable covers with interlock system - Fuse cover with interlock system
User options	- Internal arc exhausting box for 21kA / 1s - Remote operating system for Load break switch - Remote operating system for fuse combination switch - Remote operating system for Circuit Breaker - OCR (Over Current Relay) operating Circuit Breaker - Padlock system (key locking devices)
Protection index	- IP3X on front face, IP67 for SF ₆ tank

Types and diagrams

Dimension (W × H × D), mm

1. Non-Extensible LBS Feeder single RMU		
LR (1L1R)	LLL (3L)	LLLL (4L)
718 × 1186 × 752	1030 × 1186 × 752	1362 × 1186 × 752

2. Non-Extensible CB Feeder RMU				
RC (1R1C)	LC (1L1C)	LCL (2L1C)	LLCL (3L1C)	LCCL (2L2C)
718 × 1400 × 752	718 × 1400 × 752	1030 × 1400 × 752	1362 × 1400 × 752	1362 × 1400 × 752

3. Non-Extensible Switch-Fuse Feeder RMU				
RF (1R1F)	LF (1L1F)	LFL (2L1F)	LLFL (3L1F)	LFFL (2L2F)
718 × 1400 × 752	718 × 1400 × 752	1030 × 1400 × 752	1362 × 1400 × 752	1362 × 1400 × 752

4. Extensible RMU			
R	L	C	F
411 × 1437 × 752	411 × 1437 × 752	521 × 1437 × 752	521 × 1437 × 752

Load Break Switch

Susol

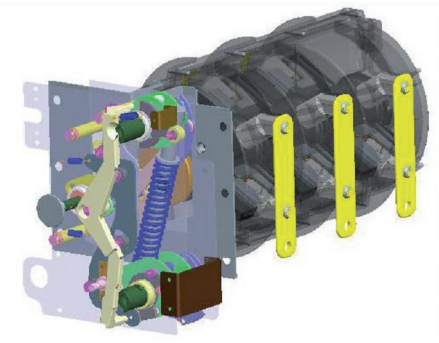

Rating

Rated voltage	kV	12	17.5	24
Rated frequency	Hz	50 / 60	50 / 60	50 / 60
Rated power frequency withstand voltage	kV	28	38	50
Rated lightning impulse withstand voltage	kV	75	95	125
Rated current	A	630	630	630
Rated short-time withstand current (3s)	kA	21	21	21
Rated short-circuit making current	kA	54.6	54.6	54.6
Electrical endurance class		E3	E3	E3
Mechanical endurance class		M1	M1	M1
Earthing switch				
Rated short-time withstand current (3s)	kA	21	21	21
Rated short-circuit making current	kA	54.6	54.6	54.6
Electrical endurance class		E1	E1	E1
Mechanical endurance class		M1	M1	M1

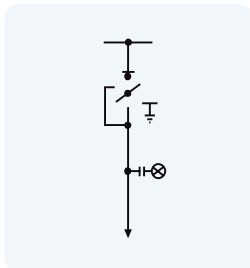

Standard features

- 3-position Load Break Switch rated 630A and less for load breaking and earthing
- Operating mechanism with two separate shaft for load and earthing function
- Switch position indication for LBS and ES
- Cable bushing horizontal in front with integrated capacitor for voltage indication

Optional features

- Motor operation for load break switch
- Auxiliary switches
 - Load break switch position
 - Earthing switch position
- Voltage indicating system
- Short circuit and earth fault indicator

Operation of 3-Position Load Break Switch

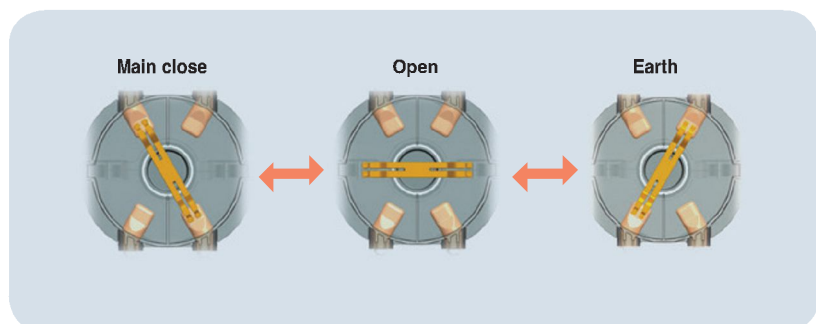

Circuit Breaker

Susol

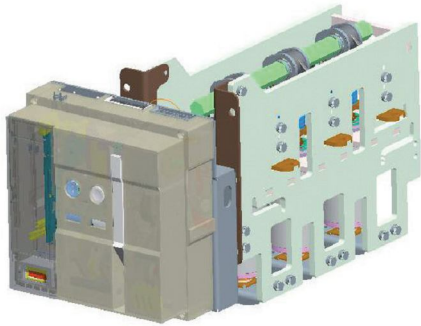

Rating

Rated voltage	kV	12	17.5	24
Rated frequency	Hz	50 / 60	50 / 60	50 / 60
Rated power frequency withstand voltage	kV	28	38	50
Rated lightning impulse withstand voltage	kV	75	95	125
Rated current	A	200 / 630	200 / 630	200 / 630
Rated short-time withstand current (3s)	kA	21	21	21
Rated short-circuit making current	kA	54.6	54.6	54.6
Electrical endurance class		E2	E2	E2
Mechanical endurance class		M1	M1	M1
Disconnecter and Earthing switch				
Rated current	A	630	630	630
Rated short-time withstand current (3s)	kA	21	21	21
Rated short-circuit making current	kA	54.6	54.6	54.6
Electrical endurance class		E1	E1	E1
Mechanical endurance class		M1	M1	M1

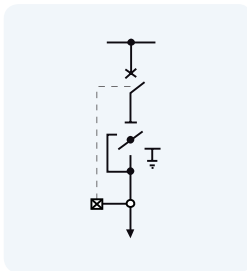

Standard features

- Circuit Breaker with 21kA interrupting capacity for the transformer and line protection
- 3-position DS disconnecting and earthing switch
- Switch position indication for CB and DS / ES
- Cable bushing horizontal in front
- Interlocking between CB and DS / ES

Optional features

- Motor operation for Circuit Breaker
- Auxiliary switches
 - CB position
 - Disconnecter position
 - Earthing switch position
- Voltage indicating system
- Trip coil and close coil

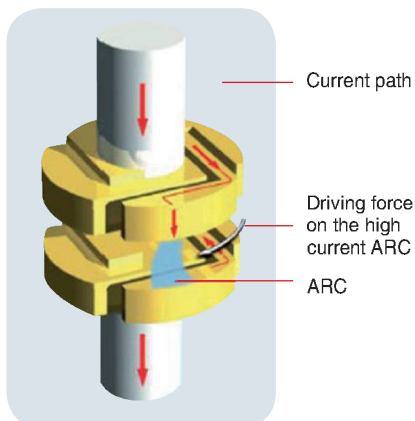

Vacuum interrupter

In the closed position, normal current flows through the interrupter. When a fault occurs and interruption is required, the contacts are quickly separated. The arc drawn between the surfaces of contact is rapidly moved around the slotted contact surface by self induced magnetic effects, preventing gross contact erosion and the formation of hot spot on the surface. The arc burns in an ionized metal vapor, which condenses on the surrounding metal shield. At current zero the arc extinguishes and vapor production ceases. The metal vapor plasma is very rapidly dispersed, cooled, recombined, and deionized, and the metal vapor products are quickly condensed so that the contacts withstand the transient recovery voltage.

Switch-fuse combination

Susol

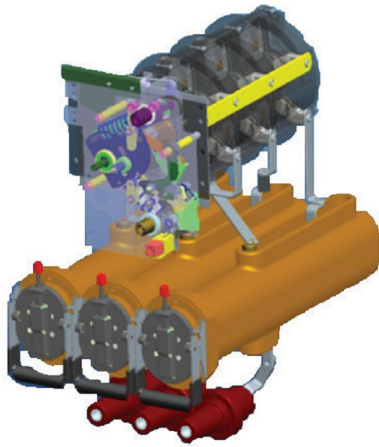

Rating

Rated voltage	kV	12	17.5	24
Rated frequency	Hz	50 / 60	50 / 60	50 / 60
Rated power frequency withstand voltage	kV	28	38	50
Rated lightning impulse withstand voltage	kV	75	95	125
Rated current	A	200	200	200
Electrical endurance class		E1	E1	E1
Mechanical endurance class		M1	M1	M1
Earthing switch				
Rated short-time withstand current (1s)	kA	5	5	5
Rated short-circuit making current	kA	13	13	13
Electrical endurance class		E1	E1	E1
Mechanical endurance class		M1	M1	M1

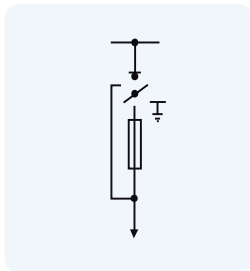

Standard features

- 3-position switch-fuse combination with earthing switch
- Switch position indication for switchfuse combination and earth switch
- Cable bushing horizontal in front
- Fuse holder for DIN type fuse-links
- Fuse-link rating
 - 12 / 17.5kV : max. 100 A, LSIS DIN type fuse-link
 - 24kV : max. 75 A, LSIS DIN type fuse-link
- Automatically tripped to protect from fault current when a fuse is blown

Optional features

- Motor operation for switch-fuse combination
- Auxiliary switches
 - LBS position
 - Earthing switch position
 - Fuse blown status
- Voltage indicating system
- Trip coil

Cable compartment

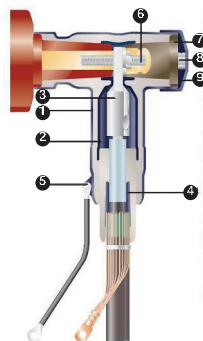
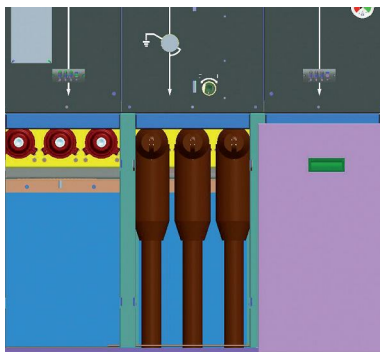

1. Screened body
2. Inner screen
3. Compressing lug
4. Stress cone adapter
5. Earthing eye and lead
6. Theaded pin
7. Rear plug with test point
8. Test point
9. Conductive end cap

Optional components

Susol



OCR (Current Relay) : CT powered protection relay

This relay is self-powered relay by the CT in Susol RMU and can be set with definite time and inverse time characteristics for short circuit, overload and earth fault current. Parameter setting can be done in different user-friendly ways, computer controlled or with HEX switches on the front. The relay is also provided with a digital memory for the storage of the most recent tripping values. This relay has proven to be a reliable and widely accepted method of protection in worldwide distribution networks.



CT (Current transformer)

Max. system voltage	kV	0.6
Primary current	A	7.2 / 14.4 / 28.8 / 57.6 / 115.2 / 230.4
Secondary current	A	0.075
Rated burden	VA	0.1
Accuracy class		10P80
Short time-current	KA / 3s	21
Rated frequency	Hz	50 / 60



Voltage indicator lamps (Voltage Detector)

It is a device to check the presence or absence of voltage in the cables. It is conforming to IEC standard 61958. Push button type LED voltage indicator is provided and lamp power is supplied by bushing type capacitive dividers.

Optional components

Susol



Power Fuse

Features

1. The LS HRC Power Fuses belong to the PRIME MEC series. It interrupts high currents before the peak value and therefore cuts down the required withstand capacity of the associated equipment on the electric system.
2. Though small in size, it has a high breaking capacity and its enclosed type is suitable for use inside of the panel board.
3. PRIME-MEC fuses are equipped with striker pins for trip indicators as well as for inflicting impulse to trip link of related load break switches.

Selection of fuses: According to IEC 60787(24kV)

Transformer rating capacity (kVA)	Power Fuse rated current (A)
36 ~75	5
75 ~ 157	10
172 ~ 358	20
258 ~ 538	30
464 ~840	40
598 ~ 1048	50
745 ~ 1320	63
1000 ~ 1572	75

Note) Please ask fuse maker for optimum selection of fuses.

Power fuse characteristic curve

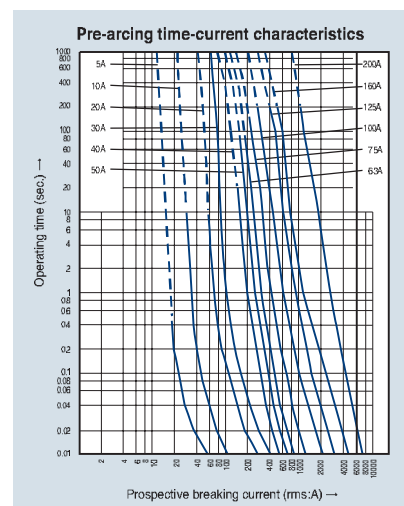
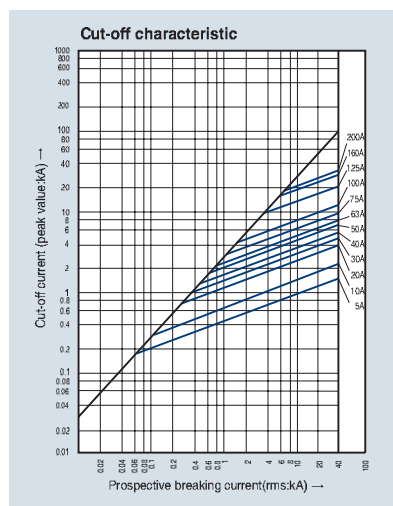

Optional components

Susol

Optional components for LBS / F-LBS mechanism

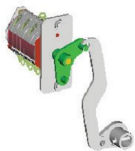
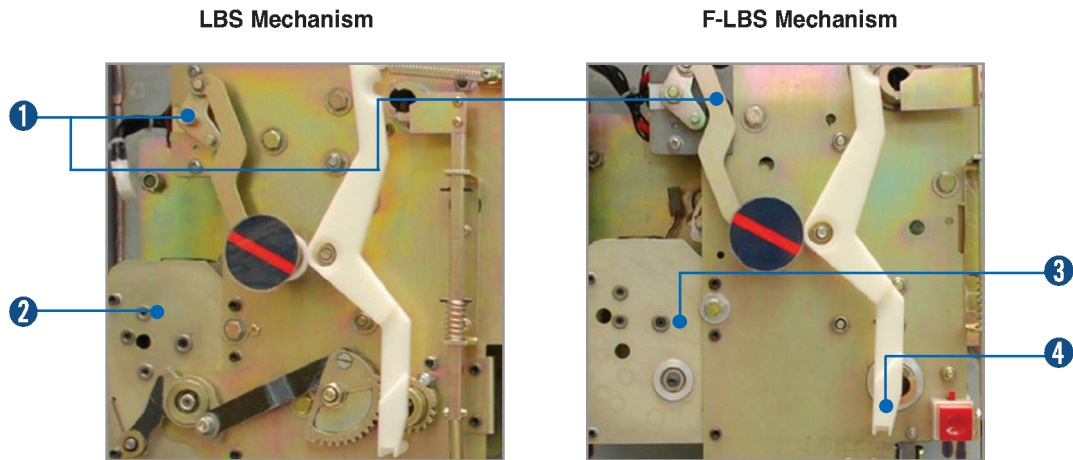

1 Auxiliary switch for LBS / F-LBS

It is a contact used to monitor ON / OFF position of Load break switch / fuse combination switch from remote place

*Standard ON / OFF / EARTH for each position

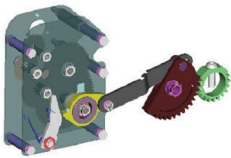

2 Geared motor for LBS mech

Charge the closing and opening spring of a load break switch by the external power source.

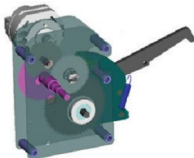

3 Geared motor for F-LBS mech

Charge the closing spring of a fuse combination switch by the external power source.



4 SHT coil for F-LBS mech

SHT is a control device which opening a fuse combination switch from remote place when applying voltage continuously or instantaneously place, over 200ms to coil terminals

Optional components

Susol

Optional components for CB mechanism

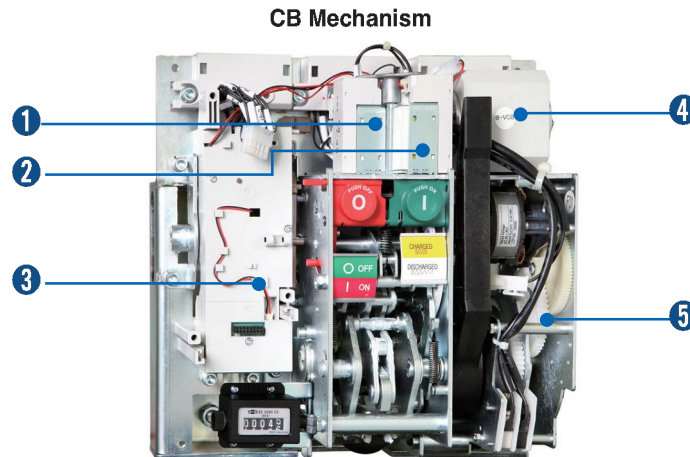

1 SHT coil for CB

SHT is a control device which trips a Circuit Breaker from remote place, when applying voltage continuously or instantaneously over 200ms to coil terminals



2 Closing coil for CB

It is a control device which closes a Circuit Breaker, when the voltage is applied continuously or instantaneously over 200ms to the coil terminals



3 MTD (Magnetic Tripping Device)

It is a control device which trips a Circuit Breaker from the OCR, when the short circuit current or overload current occurred

*Tripping time could be set by the OCR t-settings



4 Auxiliary switch for CB

It is a contact used to monitor ON / OFF position of Circuit Breaker from remote place



5 Geared motor for CB

Charge the closing spring of a Circuit Breaker by the external power source.

*Operating voltage range → 85%~110% Vn

CB-Trip alarm contact

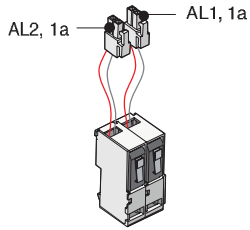

- When a Circuit Breaker is tripped by OCR which operates against the fault current (Over Current Relay), Trip Alarm switch provides the information regarding the trip of Circuit Breaker by sending the electrical signal from the mechanical indicator on main cover of main Circuit Breaker or internal auxiliary switch. (Installed at the inside of Circuit Breaker)
- When a Circuit Breaker is tripped by fault current, a mechanical trip indicator (MRB, Manual Reset Button) pops out from the main cover and the switch (AL) which sends control signal electrically is conducted to output the information occurred from fault Circuit Breaker
- MRB and AL can be operated only when tripped by OCR, but doesn't be operated by Off button and OFF operation of trip coil.
- To re-close a Circuit Breaker after a trip, press MRB to reset it for closing.
- 2pcs of electrical trip switch (AL1, AL2, 1a) are provided (Option)
- Trip alarm contact and MRB (Manual reset button) need to be purchased together

MRB (Manual Reset Button)

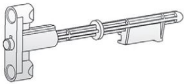

- It is a function which resets a Circuit Breaker manually when a Circuit Breaker is tripped by OCR.
- When a Circuit Breaker tripped by fault current, a mechanical trip indicator (MRB, Manual Reset Button) pops out from the main cover and the switch (SDE) which sends control signal electrically is conducted to output the information occurred from fault Circuit Breaker.
- MRB can be operated only by OCR but not by OFF operation of Circuit Breaker, To re-close a Circuit Breaker after a trip, press MRB to reset it for closing.

EFI (Earth fault indicator)



- EFI can be installed at RMU frame or anywhere customer wants.
- Single Phase AC supply split core type sensor
 - Automatic resetting function on AC 220~230V3Ph
 - 3Phase

Operational sequence

Susol

Operational sequence for CB

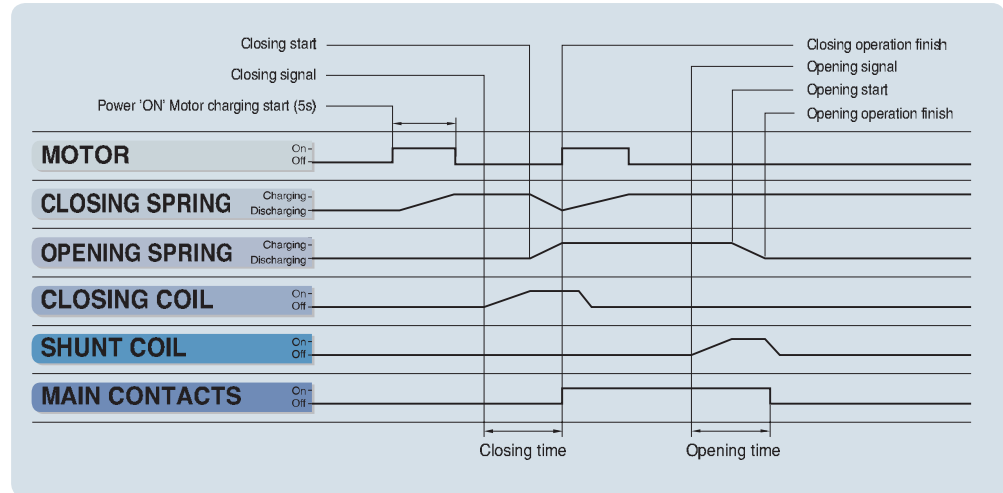

Operational sequence for LBS

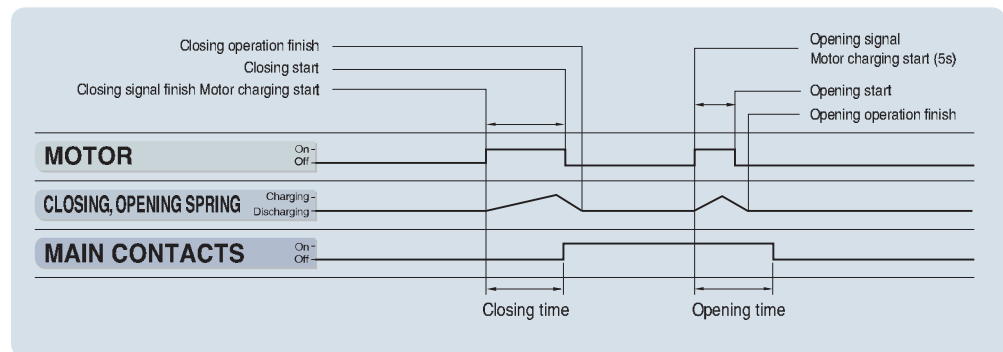

Operational sequence for F-LBS

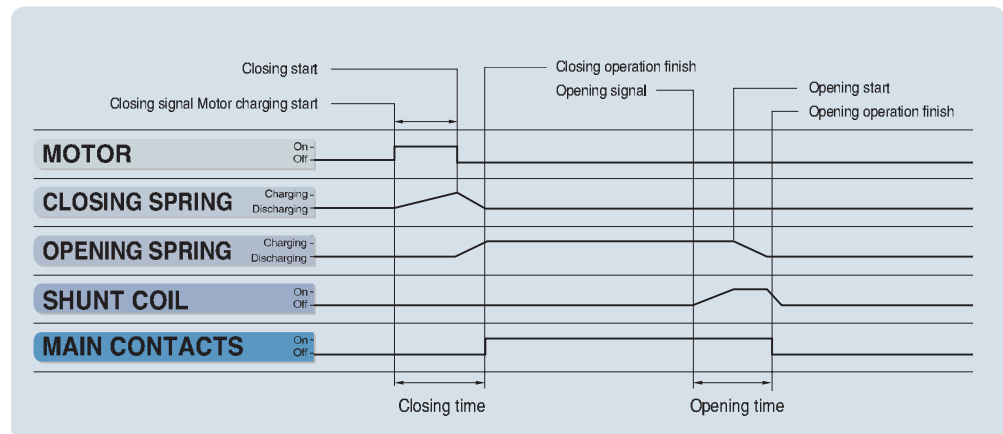

Dimensions

Susol

1. Non-Extensible LBS Feeder single RMU

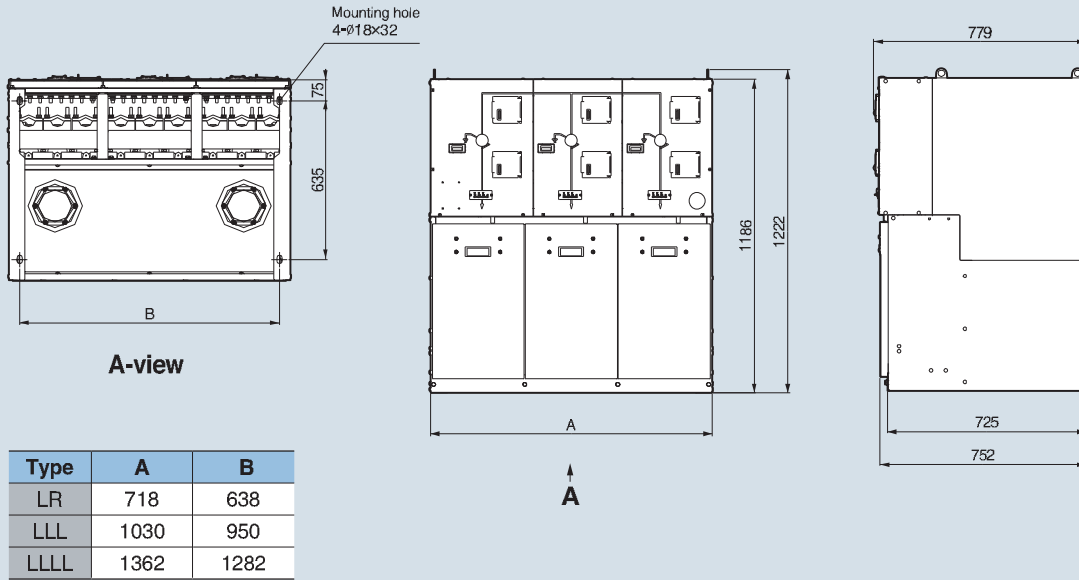

2. Non-Extensible CB Feeder RMU

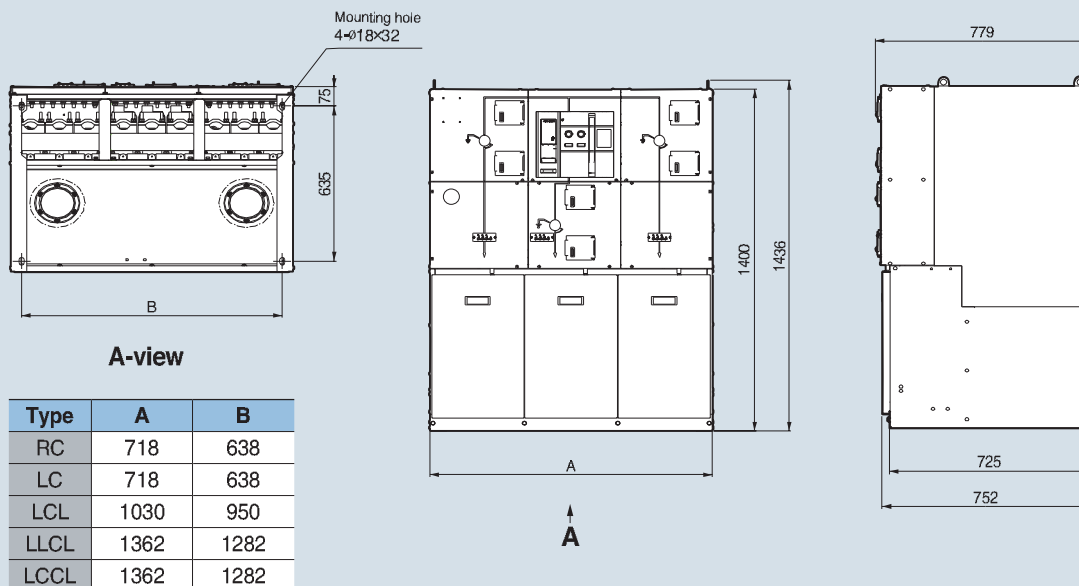

Dimensions

Susol

3. Non-Extensible Switch-Fuse Feeder RMU

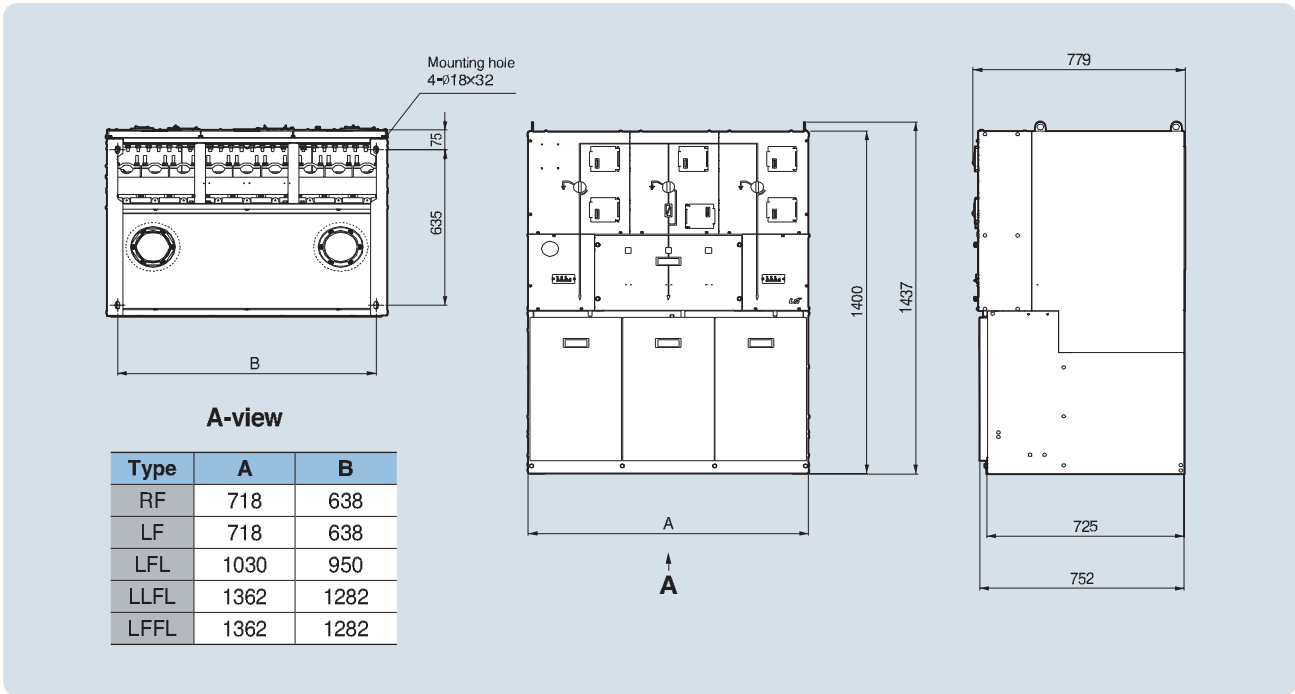

4. Extensible RMU

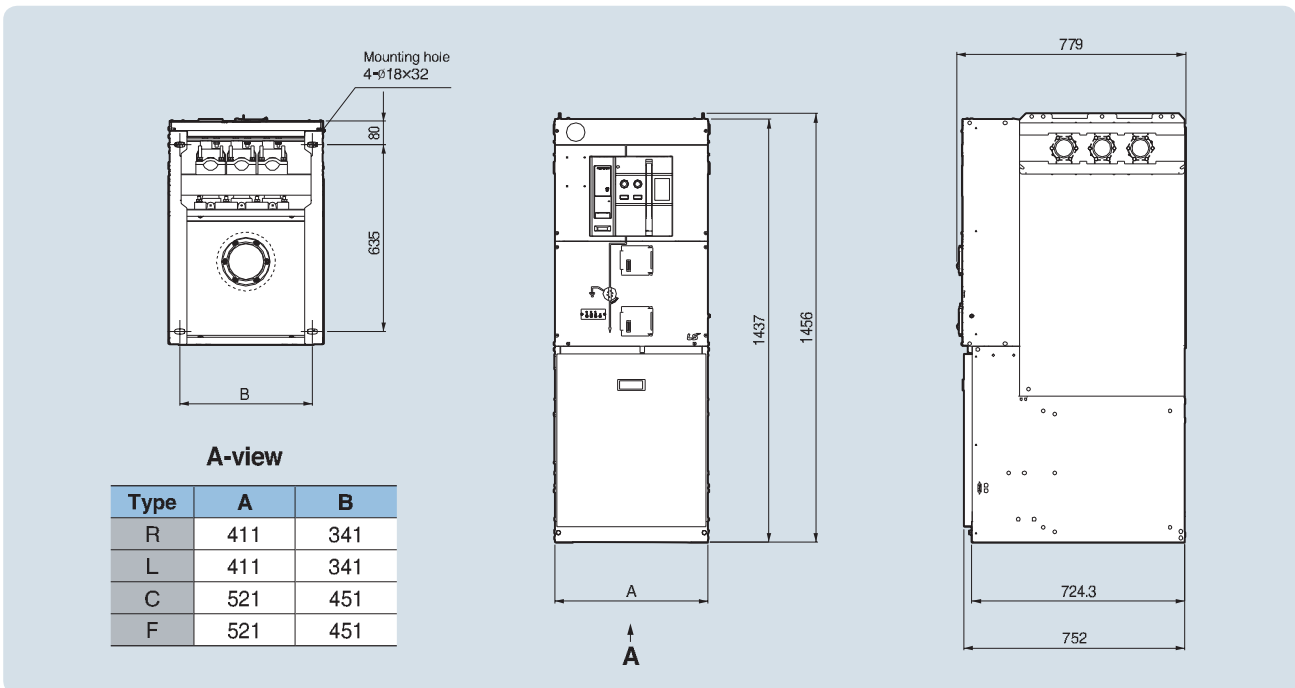

Ordering Information

Susol

1. Non-Extensible LBS Feeder single RMU

LR	B	24	6	0	0	0						
Type	Operation	Code	Rated Voltage	Code	Rated Current (Main)	Code	Rated Current (T-OFF)	Code	Rated Frequency	Code	Oder Type	Code
LR	Manual	B	24kV	24	630A	6	N / A	0	60 / 50Hz	0	SKD	S
LLL	AC 110V	A1	17.5kV	17							CKD	C
LLLL	AC 220V	A2	12kV	12							Complete Product	0
	DC 110V	D1										
	DC 220V	D2										

2. Non-Extensible CB Feeder RMU

RC	B	24	6	6	6	0						
Type	Operation	Code	Rated Voltage	Code	Rated Current (Main)	Code	Rated Current (T-OFF)	Code	Rated Frequency	Code	Oder Type	Code
RC	Manual	B	24kV	24	630A	6	630A	6	60Hz	6	SKD	S
LC	AC 110V	A1	17.5kV	17			400A	4	50Hz	5	CKD	C
LCL	AC 220V	A2	12kV	12			200A	2	60 / 50Hz	0	Complete Product	0
LLCL	DC 110V	D1										
LCCL	DC 220V	D2										

3. Non-Extensible Switch-Fuse Feeder RMU

RF	B	24	6	6	6	0						
Type	Operation	Code	Rated Voltage	Code	Rated Current (Main)	Code	Rated Current (T-OFF)	Code	Rated Frequency	Code	Oder Type	Code
RF	Manual	B	24kV	24	630A	6	200A	2	60 / 50Hz	0	SKD	S
LF	AC 110V	A1	17.5kV	17							CKD	C
LFL	AC 220V	A2	12kV	12							Complete Product	0
LLFL	DC 110V	D1										
FFFL	DC 220V	D2										

4. Extensible RMU

R	B	24	6	6	6	0						
Type	Operation	Code	Rated Voltage	Code	Rated Current (Main)	Code	Rated Current (T-OFF)	Code	Rated Frequency	Code	Oder Type	Code
R	Manual	B	24kV	24	630A	6	630A	6	60Hz	6	SKD	S
L	AC 110V	A1	17.5kV	17			400A	4	50Hz	5	CKD	C
C	AC 220V	A2	12kV	12			200A	2	60 / 50Hz	0	Complete Product	0
F	DC 110V	D1										
	DC 220V	D2										

Quality assurance

Susol

Certified quality

: STL (The Short-Circuit Testing Liaison, KERI), ISO 9001, ISO 14001

LSIS has integrated a functional organization into each of its units, the main purpose of which is to check quality and ensure the adherence to standards.



Routine quality check

While producing Susol RMU, various routine tests are taken for product capacity. Tested items are as shown follows.

- Filling pressure check
- Tightness check
- Manual and motor operation check
- Dielectric check
- Contact resistance check
- OCR operation check



Safety Instructions

- For your safety, please read user's manual thoroughly before operating.
- Contact the nearest authorized service facility for examination, repair, or adjustment.
- Please contact qualified service technician when you need maintenance.
Do not disassemble or repair by yourself!
- Any maintenance and inspection shall be performed by the personnel having expertise concerned.

LSIS Co., Ltd.

© 2014.12 LSIS Co., Ltd. All rights reserved.

www.lsis.com

■ **HEAD OFFICE**

LS-ro 127 (Hogye-dong) Dongan-gu Anyang-si
Gyeonggi-do Korea
Tel. (82-2)2034-4840, 4911, 4914
Fax. (82-2)2034-4648

■ **CHEONG-JU PLANT**

Cheong-Ju Plant #1, 95 Baekbong-ro Heungdeok-gu
Cheongju-si Chungcheongbuk-do 361-720 Korea

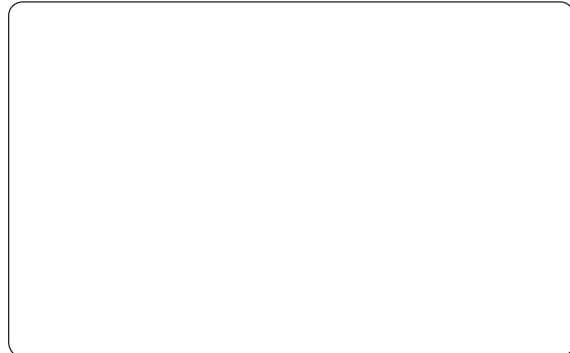

Specifications in this catalog are subject to change without notice due to continuous product development and improvement.

■ **Global Network**

- **LSIS USA Inc. » Chicago, America**
Address : 2000 Millbrook Drive, Lincolnshire, Chicago, IL 60069, United States of America
Tel : 847-941-8240 Fax : 847-941-8259 e-mail : seungheonc@lsis.com
- **LSIS (Middle East) FZE » Dubai, U.A.E.**
Address : LOB 19 JAFZA VIEW TOWER Room 205, Jebel Ali Freezone P.O. Box 114216, Dubai, United Arab Emirates
Tel : 971 4 886 5360 Fax : 971 4 886 5361 e-mail : hschob@lsis.com
- **LSIS Europe B.V. » Schiphol-Rijk, Netherlands**
Address : 1st. Floor, Tupolevlaan 48, 1119NZ, Schiphol-Rijk, The Netherlands
Tel : 31-20-654-1420 Fax : 31-20-654-1429 e-mail : junshickp@lsis.biz
- **LS-VINA Industrial Systems Co., Ltd. Hanoi, Vietnam**
Address : Nguyen Khe, Dong Anh, Hanoi, Vietnam
Tel : 84-4-6275-9055 Fax : 84-4-3882-0220 e-mail : sjbaik@lsis.biz
- **LSIS Co., Ltd. Rep. Office, Vietnam**
Address : Gema Dept Tower 18F, 6 Le Thanh Ton, District 1, HCM, Vietnam
Tel : 84-8-3823-7890 Fax : e-mail : hjchoid@lsis.biz
- **LSIS Gurgaon Office » Gurgaon, India**
Address : 109 First Floor, Park Central, Sector-30, Gurgaon- 122 002, Haryana, India
Tel : +0091-124-493-0070 Fax : 91-1244-930-066 e-mail : hwyim@lsis.biz
- **LSIS Japan Co., Ltd. » Tokyo, Japan**
Address : Toykokurakubu Bldg. 13th floor, 3-2-6, Kasumigaseki, Chiyoda-ku, Tokyo, 100-0013 Japan
TEL : +81-3-6268-8241 FAX : +81-3-6268-8240 e-mail : jschuna@lsis.biz
- **LSIS Shanghai Office » Shanghai, China**
Address : Room 32 floors of the Great Wall Building, No. 3000 North Zhongshan Road, Putuo District, Shanghai, China
Tel : 86-21-5237-9977 Fax : 89-21-5237-7189 e-mail : mkleea@lsis.com
- **LSIS Beijing Office » Beijing, China**
Address : B-Tower 17FL Beijing Global Trade Center B / D. No.36, BeiSanHuanDong-Lu, DongCheng-District, Beijing 100013, P.R. China
Tel : 86-10-5825-6025, 7 Fax : 86-10-5825-6026 e-mail : sunmj@lsis.com.cn
- **LSIS Guangzhou Office » Guangzhou, China**
Address : Room 1403, 14 / F, New Poly Tower, No.2 Zhongshan Liu Road, Guangzhou 510180, P.R. China
Tel : 020-8326-6754 Fax : 020-8326-6287 e-mail : chenxs@lsis.com.cn
- **LSIS Chengdu Office » Chengdu, China**
Address : Room 1701 17Floor, huamin hanjun international Building, No1 Fuxing Road Chengdu, 610016, P.R. China
Tel : 86-510-8534-6666 Fax : 86-28-8670-3203 e-mail : yangcf@lsis.com.cn
- **LSIS Qingdao Office » Qingdao, China**
Address : Room 2001, 20 / F, 7B40, Galaxy Building, No.29 Shandong Road, Shinan District, Qingdao 266071, P.R. China
Tel : 86-532-8501-6058 Fax : 86-532-8501-6057 e-mail : htroh@lsis.biz
- **LSIS (Wuxi) Co., Ltd. » Wuxi, China**
Address : 102-A, National High & New Tech Industrial Development Area, Wuxi, Jiangsu, 214028, P.R.China
Tel : 86-510-8534-6666 Fax : 86-510-522-4078 e-mail : wangzy@lsis.com.cn
- **Dalian LSIS Co., Ltd. » Dalian, China**
Address : No.15, Liaohexi 3-Road, Economic and Technical Development zone, Dalian 116600, China
Tel : 86-411-8273-7777 Fax : 86-411-8730-7560 e-mail : tangyh@lsis.com.cn